

# 4010T SERIES

FEATURES

## HINGE (PULL) SIDE MOUNT

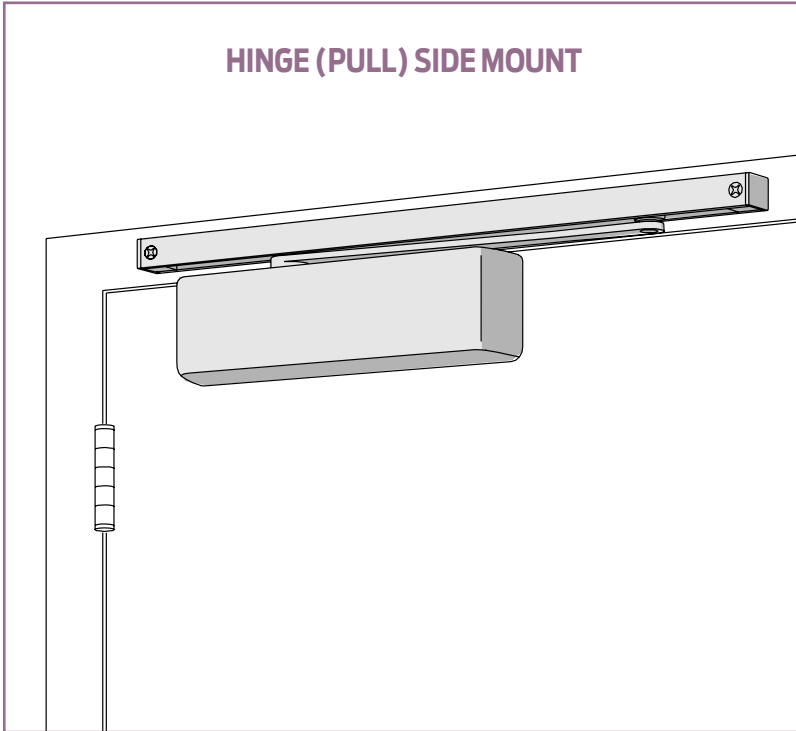

The 4010T is LCN's best performing heavy duty track closer designed specifically for interior doors in institutional and other rugged high traffic applications.

- Cast Iron
- Forged Steel Arm
- Double Heat Treated Steel Pinion
- All Weather Fluid
- UL & cUL Listed
- Peel-n-Stick Templates for Fast and Accurate Installations

- Standard 4010T Series closer is shipped with standard arm, standard track, track roller, standard plastic cover, and self reaming and tapping screws. See 4010T Series pages 9 & 10 for options.
- Sized cylinders for interior doors to 4' 0".
- Closer mounts hinge side, specify right or left swinging door.
- Standard or optional custom powder coat finish.
- Optional plated finish on metal cover, arm and fasteners.
- Optional SRI primer for installations in corrosive conditions is available with powder coat only.
- 4010T-DE available for double egress frames. See 4010T Series page 9.
- The 4010T Series is UL and cUL listed with a standard track for self-closing doors.
- Tested and certified under ANSI Standard A156.4, grade one.

| MOUNTING          |                 |                 |              |           | FINISH      |        | COVER   |       | CYLINDER   |           |               | **ARM FUNCTION |        |                  |                   |           |              |          |            |              |               |      |
|-------------------|-----------------|-----------------|--------------|-----------|-------------|--------|---------|-------|------------|-----------|---------------|----------------|--------|------------------|-------------------|-----------|--------------|----------|------------|--------------|---------------|------|
| HINGE (PULL) SIDE | TOP JAMB (PULL) | TOP JAMB (PUSH) | PARALLEL ARM | STOP FACE | POWDER COAT | PLATED | PLASTIC | METAL | NON-HANDED | NON-SIZED | ACCESSIBILITY | DELAYED ACTION | AVB*** | REGULAR (DOUBLE) | STANDARD (SINGLE) | HOLD-OPEN | FUSIBLE LINK | EDA/HEDA | CUSH/HCUSH | SCUSH/SHCUSH | DOUBLE EGRESS |      |
| ●                 | ○               | ○               | ○            | ○         | ●           | ●      | ●       | ●     | ○          | ○         | ○             | ○              | ○      | ○                | ○                 | ○         | ○            | ○        | ○          | ○            | ○             | ○    |
|                   |                 |                 |              |           |             |        |         |       |            |           |               |                |        | 180°             | 120°              |           |              |          |            |              |               | 100° |

● AVAILABLE  
○ NOT AVAILABLE

♿ Closer available with less than 5.0 lbs. Opening force @ 36"  
 \*\* Maximum opening/hold-open point with standard template.  
 \*\*\* Advanced Variable Backcheck

# 4010T SERIES

## MOUNTING DETAILS

### HINGE (PULL) SIDE MOUNTING

#### MAXIMUM OPENING

Templating allows 180° with standard arm, limited to 120° when optional bumper is installed.

Consult factory if door will be held open at 180°.

Hold-open points at , 90°, 95°, 100°, 105°, 110° or 120°, depending on the clip location in track.

Please note that many track style door closers are capable of allowing 180° of door swing. Be aware that the majority of track style closers are at their weakest closing force in the 180 – 130° range. Consult factory for applications where door must swing 180°.

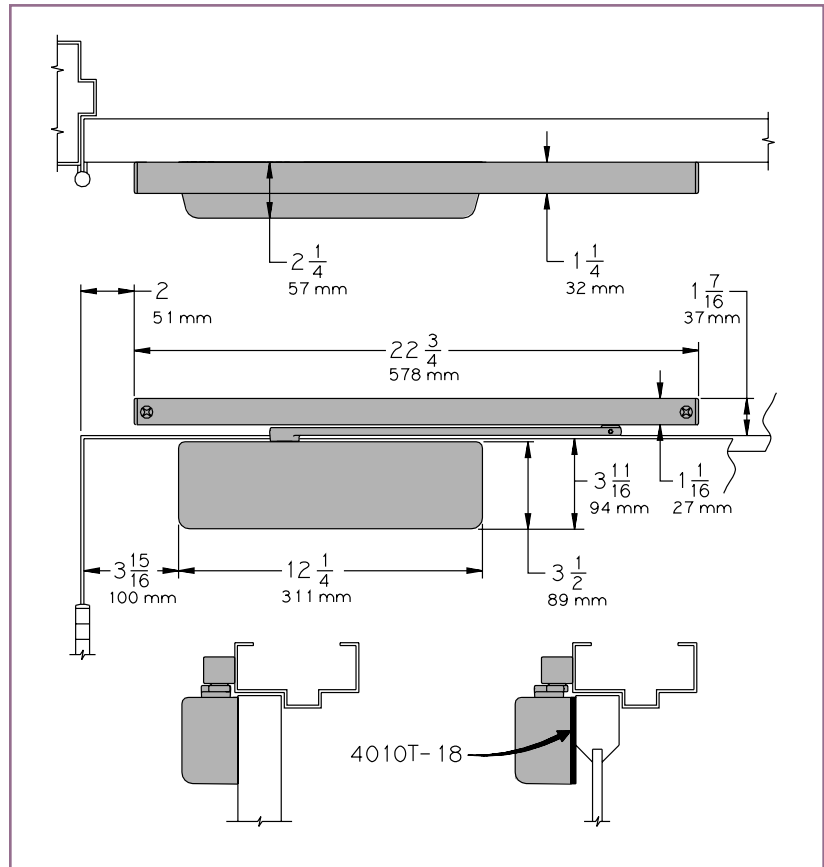

- **Butt Hinges** should not exceed 5" (127 mm) in width.
- **Auxiliary Stop** is recommended at hold-open point or where a door cannot swing 180°.
  - Note: Optional track bumper assembly assists backcheck in cushioning the opening swing of the door. It is not intended to replace an auxiliary stop.**
- **Reveal** should not exceed 1/8" (3 mm) for standard arm. Should not exceed 3-5/16" (84 mm) for double egress arm.
- **Top Rail** less than 3-3/4" (95 mm) requires PLATE, 4010T-18.
  - Note: Plate requires 2" (51 mm) minimum.**
- **Head Frame** requires 1-1/2" (38 mm) minimum.
- **Clearance** of 2-1/4" (57 mm) behind door required for 90° or 180° installation.

#### Options

- Standard track with bumper, hold-open track, hold-open track with bumper.
- Double egress arm.
- Metal cover.

#### Special Templates

Customized installation templates or products may be available to solve unusual applications. Contact LCN Product Support for assistance.

# 4010T SERIES

## CYLINDERS

### CYLINDER, 4010T-3071

Standard, handed cast iron cylinder assembly.  
For various applications see "Table of Sizes" on 4010T Series page 11. Available in sizes 1, 3, & 4.

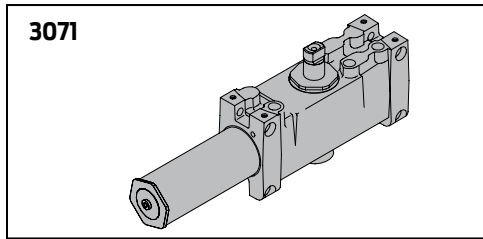

## COVERS

### COVER, 4010T-72

Standard, non-handed plastic cover.

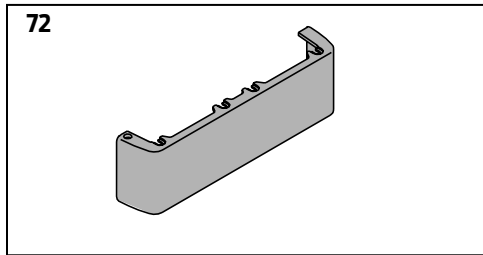

### METAL COVER, 4010T-72MC

Optional, handed cover. Required for plated finishes and custom powder coat finishes.

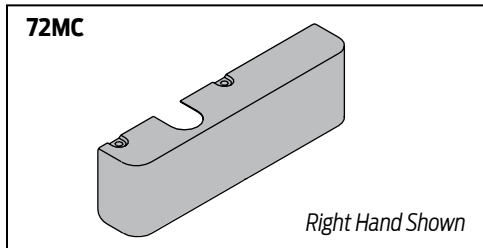

## ARMS

### STANDARD ARM, 4010T-3077T

Handed arm.  
Arm does not include track roller.

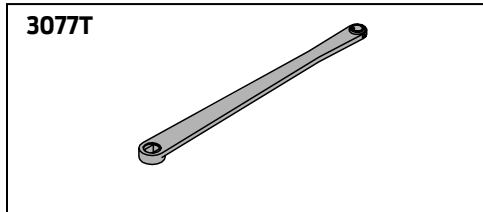

### DOUBLE EGRESS ARM, 4010T-3077DE

Optional, handed arm for double egress doors and frames.  
Arm does not include track roller.  
Maximum reveal is 3 5/16" (84mm).

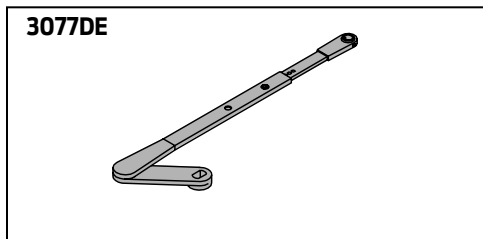

## TRACKS

### STANDARD TRACK, 4010T-3038

Standard, non hold-open, non-handed track.  
Will accept hold-open clip and/or bumper assembly.

### STANDARD TRACK with BUMPER, 4010T-3038B

Optional non hold-open, non-handed track with bumper assembly installed.  
Will accept hold-open clip.

### HOLD-OPEN TRACK, 4010T-3038H

Optional, non-handed track with hold-open clip installed.  
Will accept bumper assembly.

### HOLD-OPEN TRACK with BUMPER, 4010T-3038HB

Optional, non-handed track with hold-open clip and bumper assembly installed.

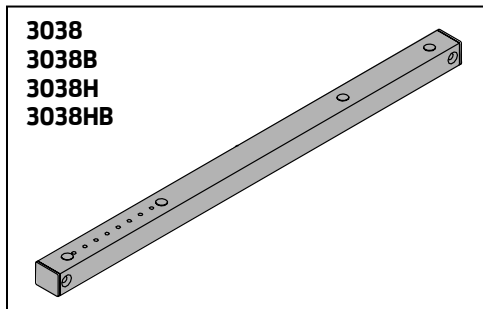

# 4010T SERIES

## INSTALLATION ACCESSORIES

### PLATE, 4010T-18

Required where top rail is less than 3-3/4" (95 mm).  
Plate requires minimum 2" (51 mm) top rail.

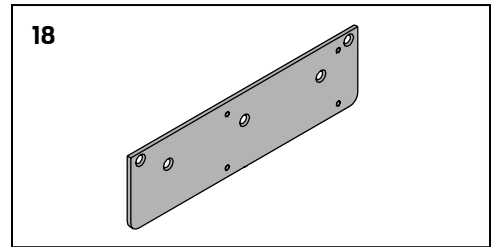

### TRACK BUMPER, 4010T-169

Mounts in track to assist backcheck, does not replace auxiliary stop.  
Limits maximum opening.  
Consists of bumper, bumper post, and mounting screw.

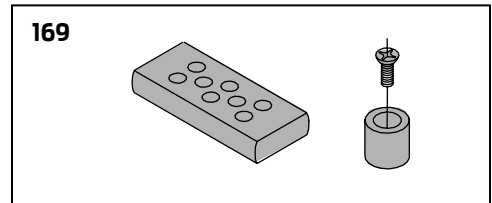

### HOLD-OPEN CLIP, 4010T-3054

Mounts in track to provide hold-open function.  
Hold-open point controlled by clip location.  
Consists of clip and mounting screws.

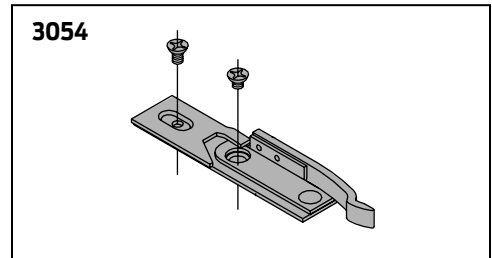

### TRACK ROLLER, 4010T-3034

Quiet, low friction roller assembly.  
Shoulder dimension "X" = 1/16" (2mm).

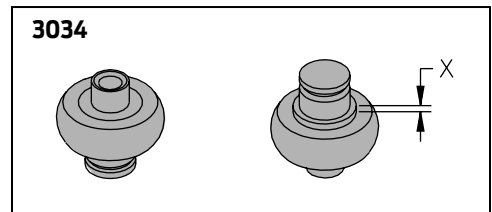

# 4010T SERIES

## TABLE OF SIZES

Select closer based on width of door.

Sized 4010T Series cylinders available in size 1, 3 or 4.

Closing power of all 4010T Series closers may be increased 15%.

### INTERIOR DOOR WIDTH

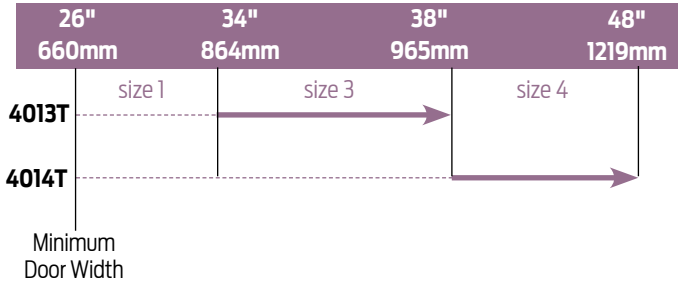

→ Indicates recommended range of door width for closer size.

\*\* Note: Using this closer on double-egress doors and frames requires the closer to be ordered with a "DE" suffix (i.e., 4014T DE). Standard "DE" option will accommodate pull side reveals up to 3-5/16". For deeper reveals, consult factory.

## REDUCED OPENING FORCE 4010T CLOSERS

**CAUTION!** Any manual door closer, including those certified by BHMA to conform to ANSI Standard A156.4, that is selected, installed and adjusted based on ADA or other reduced opening force requirements may not provide sufficient power to reliably close and latch a door.

Refer to AUTOMATIC OPERATORS section for information on systems that meet reduced opening force requirements without effecting closing power.

|  | DOOR WIDTH | 36"   | 42"   | 48"   |
|---|------------|-------|-------|-------|
|   | 8.5* lbs.  | N/A   | N/A   | N/A   |
|   | 5.0* lbs.  | 4011T | 4011T | 4011T |

\* Maximum opening force.

## HOW-TO-ORDER 4010T SERIES CLOSERS

### 1. SPECIFY CYLINDER SIZE

- 4011T (ADA)
- 4013T
- 4014T

### 2. SPECIFY HAND

- RH
- LH

### 3. SPECIFY FINISH

- Standard Powder Coat \_\_\_\_\_  
Aluminum, Dark Bronze, Statuary,  
Light Bronze, Black, Brass.

### Closer will be shipped with:

- STANDARD COVER,
- STANDARD ARM,
- TRACK ROLLER,
- STANDARD TRACK,
- SELF-REAMING and TAPPING SCREWS,  
unless options listed below are selected.

## CLOSER OPTIONS

### COVER

- Metal (MC)

### ARM

- Double Egress (DE)\*\*

### TRACK

- Regular with Bumper (BUMPER)
- Hold-Open (HO)
- Hold-Open with Bumper (HBUMPER)

### FINISH

- Custom Powder Coat (RAL) \_\_\_\_\_  
(handed metal cover required)
- Plated Finish, US \_\_\_\_\_  
(handed metal cover required)
- SRI primer (use with powder coat finishes only)

### SCREW PACK

- TB\* & SRT Screw (TBSRT)
  - Wood & Machine Screw (WMS)
  - TB\*, Wood & Machine Screw (TBWMS)
  - TORX Machine Screw (TORX)
  - TB\* & TORX Machine Screw (TBTRX)
- \* Specify door thickness if other than 1-3/4".

### INSTALLATION ACCESSORY

- Plate, 4010T-18

### SPECIAL TEMPLATE

- ST- \_\_\_\_\_