

4110 SERIES

FEATURES

*PARALLEL ARM (PUSH SIDE) MOUNT

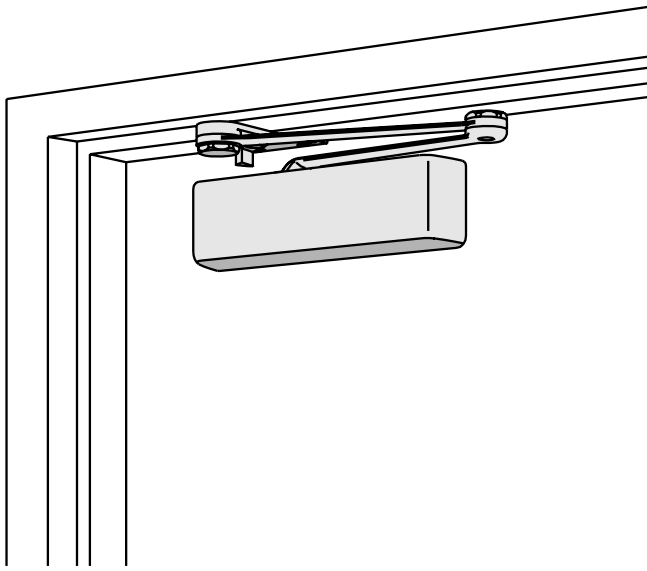

*4110 HCUSH mount shown

The 4110 is LCN's best performing heavy duty closer designed specifically for institutional and other rugged high traffic applications.

- Cast Iron
- Extra Duty Forged Steel Arm Standard
- Double Heat Treated Steel Pinion
- All Weather Fluid
- Advanced Variable Backcheck
- LCN Patented Green Dial
- UL & cUL Listed
- Peel-n-Stick Templates for Fast and Accurate Installations

- Standard 4110 Series closer is shipped with Extra Duty arm, standard plastic cover, 4110-201 FIFTH SCREW SPACER and self reaming and tapping screws. See 4110 Series pages 57 & 58 for options.
- Sized cylinders adjustable for interior doors to 5'0" and exterior doors to 4'0".
- Non-sized cylinder adjustable for interior doors to 4'6" and exterior doors to 3'6".
- Closer mounts parallel arm, specify right or left swinging door.
- 4111 cylinder meets ADA requirements. See 4110 Series page 59.
- Standard or optional custom powder coat finish.
- Optional plated finish on metal cover, arm and fasteners.
- Optional SRI primer for installations in corrosive conditions is available with powder coat only.
- The 4110 Series is UL and cUL listed for self-closing doors without hold-open.
- Tested and certified under ANSI Standard A156.4, grade one.



| MOUNTING | | | | | FINISH | | COVER | | | CYLINDER | | **ARM FUNCTION | | | | | | | | | |
|-------------------|-----------------|-----------------|--------------|-----------|-------------|--------|---------|-------|------------|-----------|---------------|----------------|--------|------------------|-------------------|-----------|--------------|----------|------------|--------------|---------------|
| HINGE (PULL/SIDE) | TOP JAMB (PULL) | TOP JAMB (PUSH) | PARALLEL ARM | STOP FACE | POWDER COAT | PLATED | PLASTIC | METAL | NON-HANDED | NON-SIZED | ACCESSIBILITY | DELAYED ACTION | AVB*** | REGULAR (DOUBLE) | STANDARD (SINGLE) | HOLD-OPEN | FUSIBLE LINK | EDA/HEDA | CUSH/HCUSH | SCUSH/SHCUSH | DOUBLE EGRESS |
| ○ | ○ | ○ | ● | ○ | ● | ● | ● | ● | ○ | ● | ♿ | ● | ● | ○ | ○ | ○ | 180° | 180° | 110° | 110° | ○ |

● AVAILABLE
○ NOT AVAILABLE

♿ Closer available with less than 5.0 lbs. opening force on 36" door.
** Maximum opening/hold-open point with standard template.
*** Advanced Variable Backcheck.

4110 SERIES

PARALLEL ARM (PUSH SIDE) MOUNTING

MAXIMUM OPENING

EDA or Fusible Link arm can be templated for

100°

Ⓐ = 5-15/16" (151 mm)

Ⓑ = 7-1/4" (184 mm)

140°

Ⓐ = 4-7/16" (113 mm)

Ⓑ = 5-3/4" (146 mm)

or 180°

Ⓐ = 2-15/16" (75 mm)

Ⓑ = 4-1/4" (108 mm)

Hold-open points up to maximum opening with HEDA or Fusible Link arm.

CUSH arm can be templated for maximum opening at

85°

Ⓐ = 8-5/16" (211 mm)

Ⓑ = 9-5/8" (244 mm)

90°

Ⓐ = 7-11/16" (195 mm)

Ⓑ = 9" (229 mm)

100°

Ⓐ = 6-7/16" (164 mm)

Ⓑ = 7-3/4" (197 mm)

or 110°

Ⓐ = 5-9/16" (141 mm)

Ⓑ = 6-7/8" (175 mm)

Hold-open point at maximum opening with HCUSH arm.

Spring Cush hold-open points are approximately 5° less than templated stop point.

Options

- Size 6 or non-sized cylinder.
- Delayed Action and/or Advanced Variable Backcheck cylinder.
- HEDA, CUSH, HCUSH, SPRING CUSH, SPRING HCUSH or Fusible Link arm.
- Metal cover.

Special Templates

Customized installation templates or products may be available to solve unusual applications. Contact LCN Product Support for assistance.

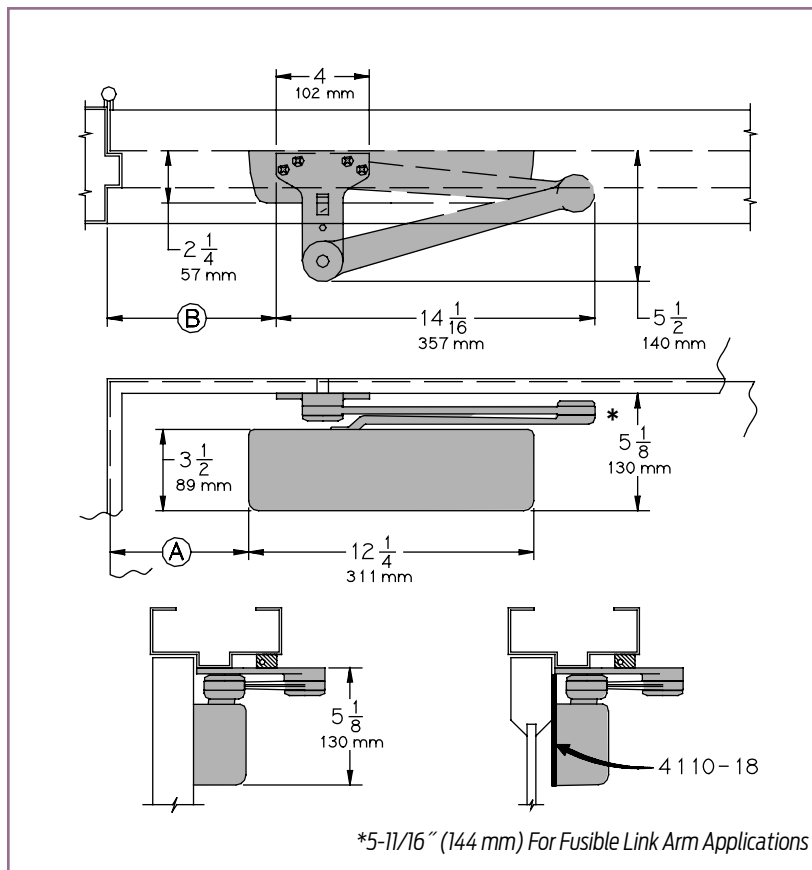

- **Butt Hinges** should not exceed 5" (127 mm) in width.
- **Auxiliary Stop** is recommended at hold-open point, where a door cannot swing 180°, or where CUSH-N-STOP arm is not used.
- **Clearance** for EDA, or CUSH shoe is 5-1/2" (140 mm) from door face.
- **Top Rail** less than 5-1/8" (130 mm) measured from stop requires PLATE, 4110-18. Plate requires 2" (51 mm) minimum measured from the stop.
- **Stop Width** minimum 1" (25 mm).
- **Head Frame** flush or rabbeted requires CUSH FLUSH PANEL ADAPTER, 4110-419.
- **Reveal** less than 2-3/4" (70 mm), use CUSH SHOE SUPPORT, 4110-30 with CUSH arms.
- **Blade Stop Spacer**, 4110-61 required to clear 1/2" (13 mm) blade stop.
- **Cush Arm** requires CUSH SHOE SUPPORT, 4110-30 for fifth screw anchorage with CUSH arms.
- **Delayed Action** Add suffix "DEL" to selected cylinder (eg. 4111 DEL). Not available with 4116 cylinder. Delays closing from maximum opening to approximately 70°. Delay time adjustable up to approximately 1 minute.
- **Advanced Variable Backcheck** cylinder starts backcheck at approximately 45° instead of the normal 75°. Add suffix "AVB" to selected cylinder.

4110 SERIES

CYLINDERS

CYLINDER, 4110-3071

Standard, handed cast iron cylinder assembly.
For various applications see "Table of Sizes" on 4110 Series page 59.

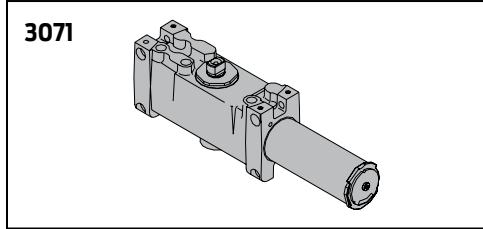

COVERS

COVER, 4110-72

Standard, non-handed plastic cover.

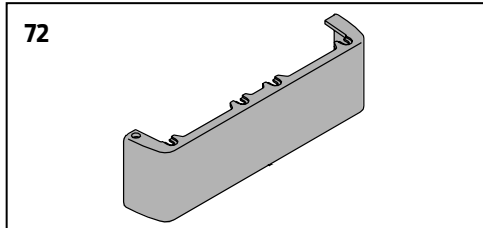

METAL COVER, 4110-72MC

Optional, handed cover. Required for plated finishes and custom powder coat finishes.

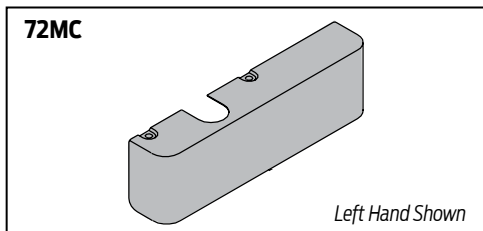

ARMS

EXTRA DUTY ARM, 4110-3077EDA, 4110-3077EDAG

Non-handed parallel arm features forged, solid steel main and forearm for potentially abusive installations.
Optional 4110-62G thick hub shoe for blade stop clearance.

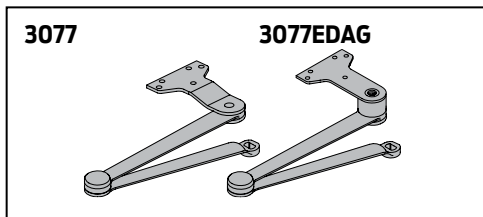

HOLD-OPEN ARM 4110-3049EDA

Optional handed arm provides hold-open function, adjustable at shoe.

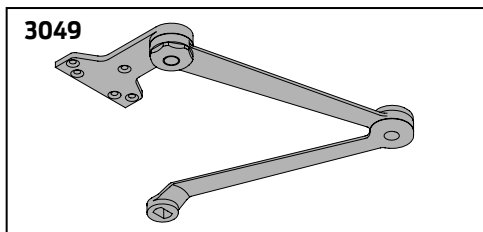

FUSIBLE LINK ARM, 4110-3049FL

Optional, handed arm releases hold-open function adjustable at shoe when exposed to temperatures above 165° F.

NOTE: Check local codes before specifying FL arms. NOT A life safety product!

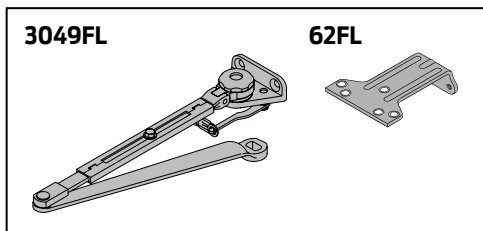

CUSH-N-STOP ARM, 4110-3077CNS

Non-handed parallel arm features solid forged steel main arm and forearm with built-in stop in soffit shoe.

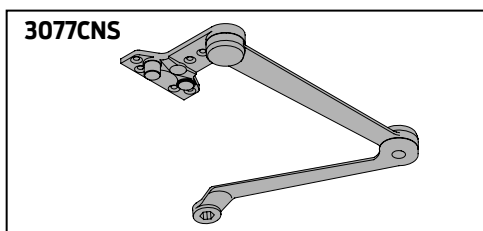

4110 SERIES

H-CUSH ARM 4110-3049CNS

Non-handed arm provides hold-open function with templated stop/hold-open points. Handle controls hold-open function.

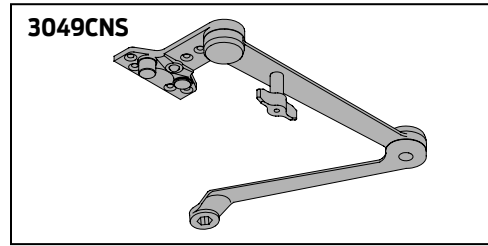

SPRING CUSH ARM, 4110-3077SCNS

Optional, non-handed parallel arm for abusive applications features solid forged steel main arm and forearm with spring loaded stop in the soffit shoe.

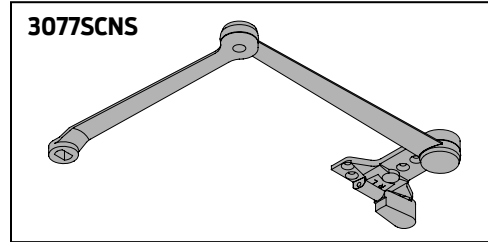

SPRING H-CUSH ARM, 4110-3049SCNS

Optional, non-handed parallel arm for abusive applications features solid forged steel main arm and forearm with spring loaded stop in the soffit shoe. Handle controls hold-open function.

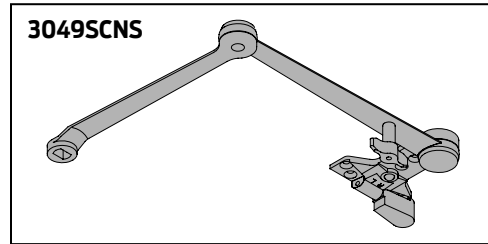

INSTALLATION ACCESSORIES

PLATE, 4110-18

Required for push side mount where top rail is less than 5-1/8" (130 mm), measured from the stop. Plate requires minimum 2" (51 mm) minimum top rail. Plate also used with CUSH Arm installations.

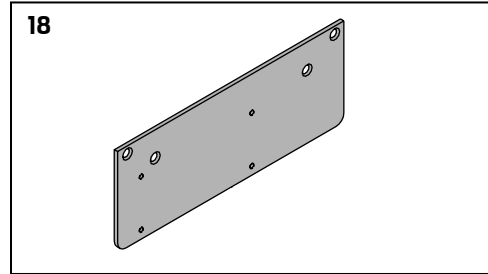

CUSH SHOE SUPPORT, 4110-30

Provides anchorage for fifth screw used with CUSH arm, where reveal is less than 3-1/16" (78 mm).

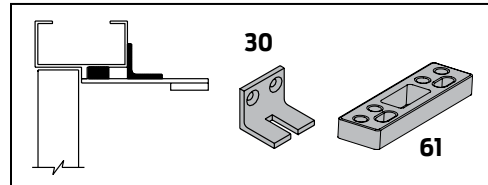

BLADE STOP SPACER, 4110-61

Lowers parallel arm shoe to clear 1/2" (13 mm) blade stop

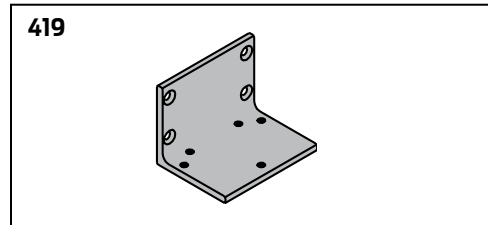

PA FLUSH PANEL ADAPTER, 4110-419

Provides horizontal mounting surface for CUSH shoe on single rabbeted or flush frame.

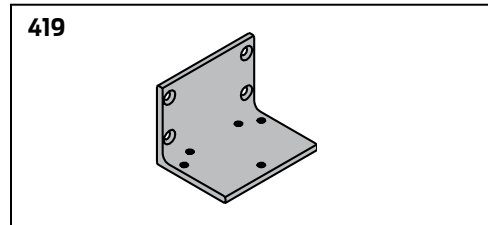

4110 SERIES

TABLE OF SIZES

Select closer based on width of door.

The spring power of non-sized 4111 cylinder is adjustable from size 1 through size 5 and is shipped set to size 3.

Sized 4116 series cylinders 6.

Delayed action not available with 4116 cylinder

H - CUSH and SPRING H-CUSH arm not available with 4116 cylinder.

EXTERIOR (and VESTIBULE) DOOR WIDTH

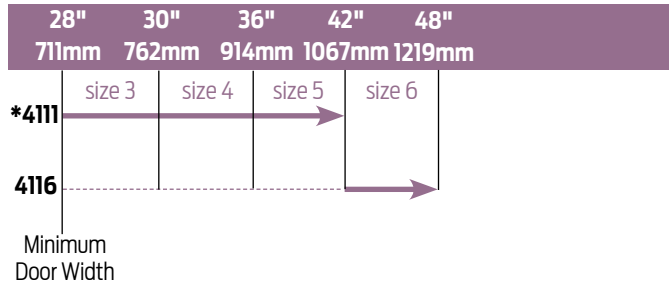

* Adjustable Size 1 thru 5

INTERIOR DOOR WIDTH

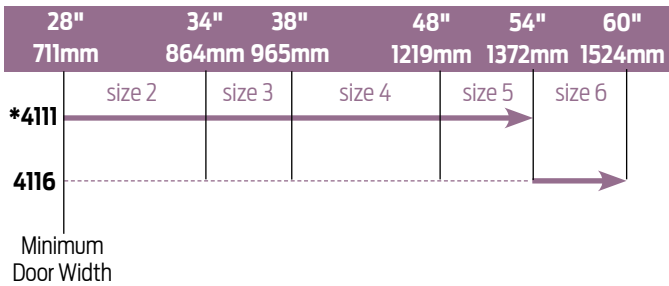

→ Indicates recommended range of door width for closer size.

* Adjustable Size 1 thru 5.

REDUCED OPENING FORCE 4110 CLOSERS

CAUTION! Any manual door closer, including those certified by BHMA to conform to ANSI Standard A156.4, that is selected, installed and adjusted based on ADA or other reduced opening force requirements may not provide sufficient power to reliably close and latch a door.

Refer to AUTOMATIC OPERATORS section for information on systems that meet reduced opening force requirements without effecting closing power.

| | DOOR WIDTH | 36" | 42" | 48" |
|--|------------|------|------|------|
| | 8.5* lbs. | 4111 | 4111 | 4111 |
| | 5.0* lbs. | 4111 | 4111 | 4111 |

* Maximum opening force.

HOW-TO-ORDER 4110 SERIES CLOSERS

1. SELECT CYLINDER SIZE

- 4111 (adjustable from size 1 to 5)
- 4116 (DEL, SHCUSH or HCUSH arm not available)

2. SPECIFY HAND

- RH
- LH

3. SELECT FINISH

- Standard Powder Coat _____
Aluminum, Dark Bronze, Statuary,
Light Bronze, Black, Brass.

Closer will be shipped with:

- STANDARD COVER,
- FIFTH SCREW SPACER,
- EDA ARM,
- SELF-REAMING and TAPPING SCREWS
unless options listed below are selected.

4110 CLOSER OPTIONS

CYLINDER

- Delayed Action (DEL) (not available with 4116)
- Advanced Variable Backcheck (AVB)

COVER

- Metal (MC)

FINISH

- Custom Powder Coat (RAL) _____
(handed metal cover required)
- Plated Finish, US _____
(handed metal cover required)
- SRI primer (use with powder coat finishes only)

SPECIFY ARM

- Hold-Open Extra Duty (HEDA)
- Fusible Link, 165° F (FL)
- Cush-N-Stop (CUSH)
- H-Cush-N-Stop (n/a with 4116 cylinder) (HCUSH)
- Spring Cush (SCUSH)
- Spring H-Cush (n/a with 4116 cylinder) (SHCUSH)
- Extra Duty (EDA)
- H-Extra Duty (HEDA)

SCREW PACK

- TB*, Self-Reaming & Tapping (TBSRT)
- Wood & Machine Screw (WMS)
- TB*, Wood & Machine Screw (TBWMS)
- TORX Machine Screw (TORX)
- TB* & TORX Machine Screw (TBTRX)
** Specify door thickness if other than 1-3/4".*

INSTALLATION ACCESSORIES

- Plate, 4110-18
- CUSH Shoe Support, 4110-30
- Blade Stop Spacer, 4110-61
- PA Flush Panel Adapter, 4110-419

SPECIAL TEMPLATE

- ST- _____